

## EZEE-FIT JUNCTION BOX

Ex e/Ex n &  
Standard



with  
Transparent or  
Black Lid



### CERTIFICATION



I.A. No. SABS S/14-228X

Ex e II T6 Gb

Ex nA II T6 Gc

Ex tb IIIC T85°C Da

IP68/IP66(2m-cont)

IEC / SANS 60079-0

IEC / SANS 60079-7

IEC / SANS 60079-15

IEC / SANS 60079-31

IEC / SANS 60529

Suitable for use in  
Zone1, 2, 21 and 22

Ex e II T6

Ex tD IP68 T85°C

IEC Ex SIR 06.0030X

Ex e II IP68

(Sira 07ATEX3118X)

EEx nA II IP68

(Sira 04ATEX4241)

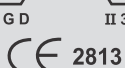

## FEATURES & BENEFITS

- Built-in Ex e cable glands.
  - Also available without gland parts.
  - Ex e and Ex n dual certified.
  - Unique Ex bands for quick identification.
  - Quick and easy to fit.
  - Reinforced, impact and corrosion resistant thermoset material.
  - Unique encapsulated earth bar ensures earth continuity to all entries.
  - Internal earth stud.
  - Accommodates either armoured or unarmoured cables of various sizes.
  - Numerous accessories available.
  - IP68 for total water and dust ingress protection.
  - Suitable for aggressive environments and burying underground.
- (Orange can be supplied on request).

### POLICY STATEMENT

"The performance of our products must exceed all others on the world market"

KGM Praty

# PRATLEY EZEE-FIT JUNCTION BOX CONFIGURATIONS & SIZES

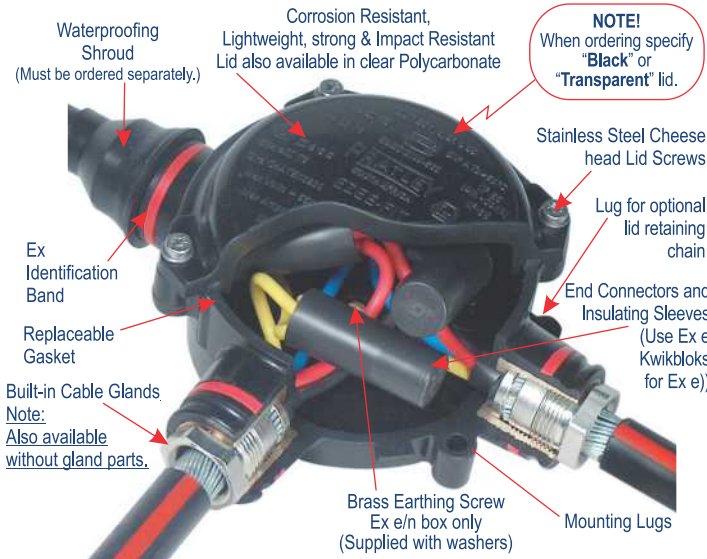

## BOX SELECTION CHART FOR ARMoured CABLE

This chart shows the maximum cable bedding diameter accommodated by each size of Junction Box.

**NOTE:** First 3 columns of this chart are based upon sizes published by cable manufacturers. Cable diameters do however vary. To be 100% sure, physically measure the bedding size and then select the appropriate box.

SWA/PVC CABLE BOX SELECTION CHART			
Cable Size	No. of Cores	Box Size	Max. Bedding Dia. (Hole Ø in box entry)
1.5 mm <sup>2</sup>	2, 3, 4, 5, 7	0	12.6 mm
	12	1	15.7 mm
	19	2	20.4 mm
	27, 37	3	26.3 mm
2.5 mm <sup>2</sup>	2, 3, 4, 5	0	12.6 mm
	7	1	15.7 mm
	12	2	20.4 mm
	19, 27	3	26.3 mm
	37	4	34.7 mm
4 mm <sup>2</sup>	2, 3	0	12.6 mm
	5, 7, 4	1	15.7 mm
	12, 19	3	26.3 mm
	27	4	34.7 mm
6 mm <sup>2</sup>	2	0	12.6 mm
	3, 5	1	15.7 mm
	7	2	20.4 mm
10 mm <sup>2</sup>	2, 3	1	15.7 mm
	4	2	20.4 mm
16 mm <sup>2</sup>	2	1	15.7 mm
	3, 4	2	20.4 mm
25 mm <sup>2</sup>	2	1	15.7 mm
	3	2	20.4 mm
	4	3	26.3 mm
35 mm <sup>2</sup>	2	2	20.4 mm
	3, 4	3	26.3 mm
50 mm <sup>2</sup>	2	2	20.4 mm
	3	3	26.3 mm
	4	4	34.7 mm
70 mm <sup>2</sup>	3, 4	4	34.7 mm
95 mm <sup>2</sup>	3	4	34.7 mm

Use Catalogue No. when ordering.

PRATLEY EZEE-FIT CABLE BOXES						
SIZE	BOX ENTRY THREAD	BOX CONFIGURATION	Ex e/n		STANDARD	
			C/W BLACK LID CAT. N <sup>o</sup>	C/W TRANSPARENT LID CAT. N <sup>o</sup>	C/W BLACK LID CAT. N <sup>o</sup>	C/W TRANSPARENT LID CAT. N <sup>o</sup>
No. 0	20 mm x 1,5 P	Two way through box	56022	56122	56200	56201
		Three way "T" box	56023	56123	56202	56203
		Four way right angle	56024	56124	56204	56205
		Three way P/E Y-type	56048	56049	56197	56198
No. 1	25 mm x 1,5 P	Two way through box	56025	56125	56206	56207
		Three way "T" box	56026	56126	56208	56209
		Four way right angle	56027	56127	56212	56213
		Three way P/E Y-type	56053	74116	56210	56211
		Four way P/E H-type	56054	56055	56238	56239
No. 2	32 mm x 1,5 P	Two way through box	56028	56128	56214	56215
		Three way "T" box	56029	56129	56216	56217
		Four way right angle	56030	56130	56220	56221
		Three way P/E Y-type	56063	74126	56218	56219
No. 3	40 mm x 1,5 P	Two way through box	56031	56140	56224	56225
		Three way "T" box	56032	56141	56226	56227
		Four way right angle	56033	56142	56230	56231
		Three way P/E Y-type	56065	56143	56228	56229
No. 4	50 mm x 2 P	Two way through box	56034	56145	56232	56233
		Three way "T" box	56035	56146	56234	56235
		Four way right angle	56036	56147	56236	56237

**NB:** • All boxes are supplied standard with built-in glands for SWA cable!  
• Waterproofing shrouds must be ordered separately.

\* Orange boxes can be supplied on request with longer lead times.

**NOTE:** Boxes with reduced (smaller) entries also available on request.

**NB:** When ordering specify "black" or "transparent" lid.

### CONFIGURATIONS

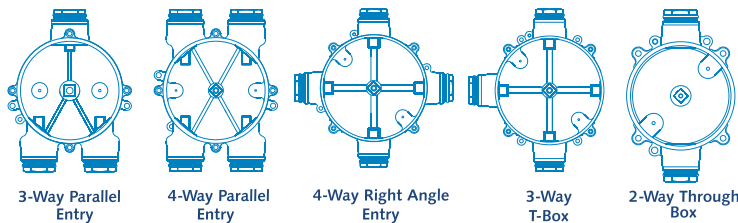

Ex e/n MARKING STANDARD  
(With Black or Transparent Lid) (With Black or Transparent Lid)

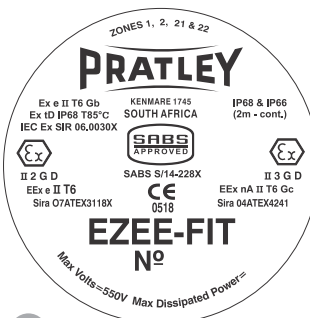

## UNIQUE BUILT-IN GLAND FOR CONVENIENCE AND SAFETY

EZEE-FIT Boxes are supplied complete with Built-in Cable Glands for SWA/PVC Cables. This means that additional glands need not be purchased and there is no danger of using non Ex rated glands. The Ex e rated built-in glands will maintain an IP68 rating against the ingress of water and dust. These glands can also be easily converted for use with unarmoured cable (see accessories on Page 4). They can also be replaced with reducing glands for smaller size cables.



Cut away view of the Ex e built-in cable gland.

## EASE OF ELECTRICAL CONNECTION

In Zone 2, 21 and 22 areas, the connection of the conductors can be achieved by either making use of rail-mounted Pratlley Kwikkbloks<sup>®</sup> or the very convenient Pratlley Non-sparking End Connectors.

**SAFETY NOTE:** For safety, in Zone 1 locations, use only Ex e approved Pratlley Kwikkbloks<sup>®</sup> and rails.



EZEE-FIT Junction box fitted with Pratlley End Connectors and insulating Sleeves. (Not for Ex e applications)

## FACTORY FITTED TO CUSTOMER SPECIFICATION

"You specify we make"

Junction boxes can be factory fitted with an **N35 mounting rail**, with earth continuity being maintained between glands and rail. Pratley **Kwikbloks**® can also be factory fitted to the customer's specification. See chart below for maximum number of Pratley Kwikbloks® per cable box. **Spacers** for lifting the mounting rail so that wires can pass underneath, are also available. The standard built-in glands can be factory substituted with **Reducing Glands** and Shrouds or with **Compression Conversion Kits** for unarmoured cable. (See accessories overleaf). **Pre cut lengths of cable** can also be factory fitted.

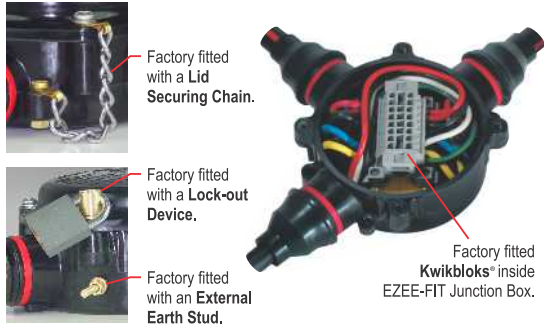

Box Size	NUMBER OF PRATLEY KWIKBLOKS® PER EZEE-FIT BOX						
	IK3 750/800V 27A	IK5 750/800V 36A	IK10 750/800V 67A	IK16 750/800V 87A	IK25 750/800V 115A	IK50 750/800V 150A	IK70 750/800V 220A
	Ex e IK3 550V 15A	Ex e IK5 550V 21A	Ex e IK10 550V 37A	Ex e IK16 550V 40A	Ex e IK25 550V 63A	Ex e IK50 550V 98A	Ex e IK70 550V 121A
	Max.	Max.	Max.	Max.	Max.	Max.	Max.
0	10	8	N/A	N/A	N/A	N/A	N/A
1	11	10	N/A	N/A	N/A	N/A	N/A
2	17	14	11	8	N/A	N/A	N/A
3	24	20	16	12	8	6*	6*
4	25	22	16	13	9	6*	6*

Max.: Number of Kwikbloks® that can be fitted.

\* Configurations where Pratley End Connectors are the preferred method of termination due to difficult bending and connecting of heavier conductors. (End Connectors are not approved for Ex e applications).

## NON-SPARKING END CONNECTORS

PRATLEY NON-SPARKING END CONNECTORS	
Connector Size	Capacity Conductor Size
Dinky	2 x 16 mm <sup>2</sup>
Small	2 x 25 mm <sup>2</sup>
Medium	2 x 35 mm <sup>2</sup> plus 1 x 25mm <sup>2</sup>
Large	3 x 35 mm <sup>2</sup> plus 1 x 25mm <sup>2</sup>
Extra Large	3 x 70 mm <sup>2</sup> plus 1 x 50mm <sup>2</sup>

## Ex e/n EZEE-FIT No. 0 INSTRUMENTATION BOX

For use when terminating extra small (Xs) diameter unarmoured instrumentation cables. Supplied complete with built-in Xs Conversion Kits for 3 mm to 6 mm diameter unarmoured cables.

**NOTE:** Kwikbloks® and mounting rail for Kwikbloks® must be ordered separately.

PRATLEY Ex e/n INSTRUMENTATION BOX			
Size	Configuration	Cat. No.	Usual pack Qty.
0	Two way through box	56009	1
	Three way T-box	56010	1
	Four way right angle	56011	1

Use Catalogue Number when ordering.



## DIMENSIONS & SPECIFICATIONS

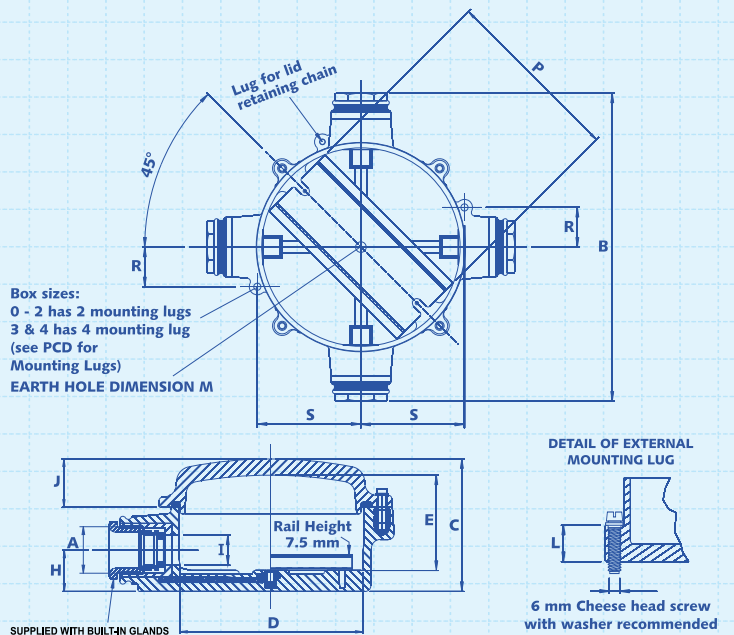

Ex e/n EZEE-FIT JUNCTION BOX DIMENSIONS																
RIGHT ANGLE ENTRY BOX																
Size	A Entry Thread	B Across Entries	C Overall Height Black Lid	D Internal Diam.	E Internal Depth Black Lid	H	I Bore	J Lid Height	PCD for Mounting Lugs	L	M Tapped Earth Stud Hole	P Rail Length	R	S		
0	20 x 1.5P	144.8	62.0	75.0	89.0	46.5	67.1	18.2	12.6	26.0	109.0	18.2	M4 x 6.0	80.0	22.5	48.5
1	25 x 1.5P	169.4	75.6	84.0	98.0	49.9	73.2	21.6	15.7	28.6	118.0	21.6	M4 x 6.0	80.0	25.4	53.1
2	32 x 1.5P	201.8	104.4	98.2	123.0	76.6	85.2	26.3	20.4	47.9	145.0	26.3	M6 x 8.0	108.0	31.8	65.1
3	40 x 1.5P	271.0	132.9	133.0	175.4	110.1	115.3	33.8	26.3	69.2	196.0	33.8	M8 x 8.0	150.0	47.6	85.7
4	50 x 2.0P	323.6	145.2	145.3	224.7	119.2	125.5	36.1	34.7	70.6	248.5	39.2	M8 x 8.0	150.0	60.3	108.7

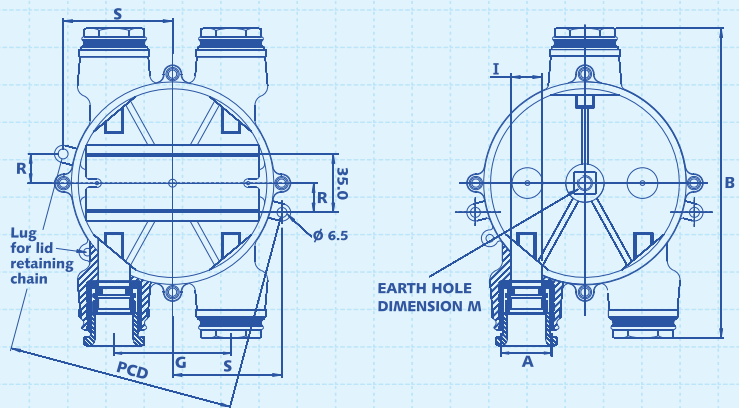

Ex e/n EZEE-FIT JUNCTION BOX DIMENSIONS																	
PARALLEL ENTRY BOX																	
Size	A Entry Thread	B Across Entries	C Overall Height Black Lid	D Internal Diam.	E Internal Depth Black Lid	G	H	I Bore	J Lid Height	PCD	L	M Tapped Earth Stud Hole	P Rail Length	R	S		
1	25 x 1.5P	169.4	75.6	90.2	98.0	56.0	79.9	63.5	21.6	15.7	28.6	118.0	21.6	M4 x 6.0	80.0	15.6	56.4
2	32 x 1.5P	201.8	104.4	104.5	123.4	82.9	91.0	76.2	26.3	20.4	47.9	144.9	26.3	M6 x 8.0	108.0	19.1	71.4
3	40 x 1.5P	271.0	139.1	139.2	176.0	113.6	121.2	101.6	33.8	26.3	69.2	196.1	33.8	M8 x 8.0	150.0	25.5	95.1

## SPECIFICATION GUIDE

\*NOTE: Specifiers may use this wording to specify the Pratley EZEE-FIT Junction Box.

### The Junction box must:

- Be dual-certified Ex e/n and be easily identifiable as Ex certified through the use of coloured identification bands on the entries.
- Be made from high strength, impact-resistant, reinforced engineering plastic suitable for use in aggressive environments and burying.
- Be supplied complete with built-in cable glands, with earthing continuity being maintained by an encapsulated earth bar and internal earth boss.
- Be convertible for use with armoured or unarmoured cables.
- Offer IP68/66 protection for sealing against water and dust.
- Be available in a range of sizes (up to No. 4 with 50 mm entry threads) and configurations.
- Have a mechanical lock-out device available as an accessory.

# ACCESSORIES

Refer to the following Sales Leaflets for further detailed information on:  
Pratley Kwikbloks® - Sales Leaflet No. 061  
Pratley End Connectors and sleeves - Sales Leaflet No. 060

## EZEE-FIT Ex e/n REDUCING GLANDS AND SHROUDS

Nickel plated Reducing glands replace the EZEE-FIT box gland parts to enable a smaller SWA cable to be fitted. A conversion kit may also be fitted into a Reducing Gland if small unarmoured cable is to be terminated.



EZEE-FIT Reducing Glands are Ex e/n rated. Reducing Shrouds cover and protect the reducing gland completely.



Box Size	Gland Size	Catalogue Number	Usual pack Qty.
1	25 - 20	58100	10
2	32 - 20	58200	10
	32 - 25	58210	10
3	40 - 20	58300	10
	40 - 25	58310	10
	40 - 32	58320	10
4	50 - 20	58400	10
	50 - 25	58410	10
	50 - 32	58420	10
	50 - 40	58430	10

Size	Catalogue Number	Usual pack Qty.
1R	35111	20
2R	35211	20
3RS	35310	20
3R	35311	20
4RS	35410	20
4R	35411	20

## EZEE-FIT Ex e/n COMPRESSION CONVERSION KITS

Compression Conversion Kits enable unarmoured cable to be fitted to the EZEE-FIT Junction Box. The kits replace the Inner Seal, Cone Bush and Compression Ring of the standard built-in gland (or Reducing gland) for SWA/PVC cable.



**NOTE:** The No. 0 kits have 1 bush. No. 1R & No. 4 Kits have 2 bushes. The No. 1, 2 & 3 Kits have 3 bushes. \* Size 1R (reducing Kit) is for size No. 1 EZEE-FIT box but reduces the entry to take smaller (size No. 0) cables.



Box Size	Kit Size	Cable Dia Min Max	Cat. No.	Usual pack Qty.
No 0	0s	6.0 9.4	62001	10
	0L	9.5 12.6	62002	10
	1R* Small	6.0 9.4	62043	10
No 1	1R* Large	9.5 12.6	62044	10
	1	12.7 15.7	62011	10
No 2	2	15.8 20.4	62021	10
No 3	3	20.5 26.3	62032	10
No 4	4	26.4 34.7	62042	10

## OPTIONAL FACTORY FITTED



See Sales Leaflet No. 061

N35 MOUNTING RAIL	
Box Size	Cat. No.
0	30110
1	30110
2	30111
3	30112
4	30112

SPACERS	
Size	Cat. No.
10 mm	30001
20 mm	30000

## Ex e/n COMPRESSION CONVERSION KITS FOR INSTRUMENTATION CABLE



The No. 0xs kit reduces the capacity of the No. 0 EZEE-FIT Box to accommodate smaller diameter instrumentation cable.



The No. 1Rxs kit reduces the capacity of the No. 1 EZEE-FIT box to accommodate smaller diameter instrumentation cable.



## No. 0xs COMPRESSION CONVERSION KIT FOR No. 0 EZEE-FIT BOX

Size	Cat. No.	Cable Dia.	Pack Qty.
0xs	62000	3-6 mm	10

## No. 1Rxs COMPRESSION CONVERSION KIT FOR No. 1 EZEE-FIT BOX

Size	Cat. No.	Cable Dia.	Pack Qty.
1Rxs	62003	3-6 mm	10

## OPTIONAL FACTORY FITTED



## EZEE-FIT GLAND PARTS

EZEE-FIT box built-in glands are supplied with the box. However, the parts can also be supplied separately if required.



PRATLEY EZEE-FIT GLAND PARTS					
Size	0	1	2	3	4
Cat. No.	57050	57051	57052	57053	57054

## BLANKING PLUGS

Box entries may be sealed by means of a Blanking Plug. To bring an entry into use again, remove the plug and fit the appropriate gland parts.



These plugs, when properly fitted, maintain the IP68/66 rating of the EZEE-FIT Box.

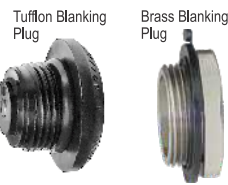

PRATLEY EZEE-FIT BLANKING PLUGS					
Size	Entry Thread	Nickel Plated Brass Cat. No.	Tufflon Cat. No.	Usual pack Qty.	
No. 0	20 mm	61080	57800	10	
No. 1	25 mm	61081	57801	10	
No. 2	32 mm	61082	57802	10	
No. 3	40 mm	61083	57803	10	
No. 4	50 mm	61084	57804	10	

## REPLACEMENT LID SCREWS

Stainless Steel screws complete with washers.

REPLACEMENT COVER SCREWS			
Cover Size	Screw Size	Cat. No.	Pack Qty.
0, 1 & 2	M5	57094	12
3 & 4	M6	57095	12

## CONDUIT ADAPTORS

EZEE-FIT Junction Boxes accept conduit directly into the entries as follows:  
No. 0 - 20 mm, No. 1 - 25 mm, No. 2 - 32 mm, No. 3 - 40 mm.

Adaptors are available to reduce the entry thread size and allow the fitting of different size conduit to the box entries. They also enable the fitting of conduit to the No. 4 box.



PRATLEY EZEE-FIT CONDUIT ADAPTORS				
Box No.	To Conduit	Cat. No.	Usual pack Qty.	
1	20 mm	68101	10	
	20 mm	68220	10	
2	25 mm	68225	10	
	20 mm	68320	10	
3	25 mm	68325	10	
	32 mm	68332	10	
	25 mm	68425	10	
4	32 mm	68432	10	
	40 mm	68440	10	
	50 mm	68450	10	

## REPLACEMENT LID GASKETS

The gaskets ensure a waterproof (IP68) seal and are very easy to fit. Gaskets should be replaced whenever inspection reveals deterioration.



REPLACEMENT GASKETS		
Size	Cat. No.	Usual pack Qty.
0	57097	1
1	57098	1
2	57099	1

## PRATLEY NON-SPARKING END CONNECTORS AND INSULATING SLEEVES

(Not for Ex e applications)  
Non-sparking Connectors may be used with Pratley EZEE-FIT Junction Boxes in Ex n and non Ex applications.

See Sales Leaflet No. 060

PRATLEY NON-SPARKING END CONNECTORS					
Size	Dinky	Small	Medium	Large	Extra Large
Catalogue No.	63200	63201	63202	63203	63204
Usual Pack Qty.	100	50	20	20	10

PRATLEY INSULATING SLEEVES					
Size	2/D	3/S	4/M	5/L	6/XL
Catalogue No.	04014	04015	04016	04017	04018
Usual Pack Qty.	50	25	20	10	10

**Black Ezee-Fit Box Lid.** Ex e/n or Standard, supplied complete with stainless steel screws and rubber gasket ready to fit. (Orange standard lids can be supplied on request).



## Ex e/n & STANDARD EZEE-FIT CABLE BOX LIDS

Size	PRATLEY EZEE-FIT CABLE BOX LIDS (BLACK & TRANSPARENT)			
	Ex e/n		Standard	
	Black Cat. No.	Transparent (Polycarbonate) Cat. No.	Black Cat. No.	Transparent (Polycarbonate) Cat. No.
0	56150	57120	56240	56245
1	56151	57121	56241	56246
2	56152	57122	56242	56247
3	56153	57123	56243	56248
4	57154	57124	56244	56249

**Transparent Ezee-Fit Lid (Polycarbonate).** Ex e/n or Standard, supplied complete with stainless steel screws and rubber gasket ready to fit.

Pratley (Pty) Limited (Reg. No. 1996/003890/07)

Jackson Street • Fatoria • Krugersdorp • Gauteng - Telephone +27 11 955 2190/8 • Fax +27 11 955 3918  
PO Box 3055, Kenmare 1745 • Gauteng • South Africa - e-mail: sales@pratley.co.za

www.pratleyelectrical.com

